

DVR - ACAP Series

Hardware Installation Guide

Rev. 1.5

Digital Video Security System
Digital Video Recorder

*All contents of this document may change without prior notice, and actual product appearance may differ from depicted herein.

INDEX

1. Specification of DVR	3
2. Products and components	5
2-1. ACAP Series Board	5
2-2. Accessories	5
2-3. Optional Accessories	6
3. Board Description	7
3-1. 120A04	7
3-2. 120A08	7
3-3. 120A16	8
3-4. I/O Board	8
4. Installation	9
4-1. 120A04	9
4-2. 120A08	10
4-3. 120A16	11
5. Accessories	12
5-1. Video Pigtail	12
5-2. Sensor Board (16 channel)	12
5-3. RS-232 to RS-485 Converter	13
5-4. Sound Recording	14
5-4-1. 1 channel sound	14
5-4-2. 2 channel sound	14

Preface

This is a guide book that explains the hardware components and provides a step-by-step installation of DVR board.

For the software explanation, please refer to “Installation and User’s Guide”.

This guide book is applicable to, among DVR products, 120A04, 120A08, and 120A16 boards.

The pictures and the name of the product are subject to change; however, the usage maybe similar.

For any questions you might have, please contact to the following address. When sending your concerned matter, please include your company name and phone number with detailed descriptions.

E-mail: support@cctvone.com

Tel: 323-721-8999

Fax: 323-721-8599

www.cctvone.com

1. Specification of DVR

- **1~16 Camera Inputs / Output**

Up to 16 camera inputs are available on screen for digital handling.

Normal input condition: 75 Ohm, 1 Volt (p-p)

- **1~16 Sensor Inputs**

Up to 16 sensors can be linked to the system.

External DC 12 Volt power must be provided to the sensor input from outside.

- **1~4 Digital Outputs (Relay Outputs)**

Digital Outputs can be used to activate things like shutters and sirens, and activation can be linked to sensor and motion detection.

- **Sound Recording and Two-Way Communication Capabilities**

Sound can be recorded with video images. Two-way communication is possible between DVR main and DVR Net.

- **Display Features (Multi-Viewing)**

Multi-Viewing allows 1, 4, 6, 9, 10, or 16 different camera shots to be displayed onscreen at the same time.

Other display features include enlarging all displayed cameras or just one. 32 channel viewing can be attained with specially configured cards.

- **PAN/TILT/ZOOM/FOCUS Capabilities**

Each connected camera can be manipulated through the DVR main program as long as each camera supports such capabilities.

- **Auto Rebooting System**

When DVR detects an error or malfunction within the system, it will automatically reboot the system in order to correct it.

- **Motion Detection and Sensor Trigger**

Detection features make it possible to record images only when movement is detected, preserving volume space and maximizing the use of physical storage space.

- **Scheduled Recording**

Scheduling allows the administrator to record images only during designated time periods, if so desired. Every combination of scheduling is available in the DVR program.

- **Manual and Auto Backup**

Data can be preserved through various formats (DAT, CD, or DVD) and data from specific cameras and/or time periods can be specifically isolated for backup as well. Much like scheduled recording, backup of data can be scheduled as well.

- **Digitalized Video Search**

Recorded data features digital playback for each camera simultaneously or one at a time. Playback features include advanced search features and image extracting, which allows portions of existing video to be extracted and saved as a separate file.

- **Network Support (PSTN, TCP/IP, LAN , Modem Protocol Support)**

DVR supports network access, which allows administrators to login to DVR main and remotely access all the features provided locally.

- **POS, Access Control, ATM Support**

Data from external devices (POS, Access Control, ATM, etc) can be recorded with DVR video images. Text Search allows to search data from external devices with DVR video image when event occurs. This will raise the level of integrity and security.

Feature	ACAP Series
Camera Input	1~16 Ports (NTSC/PAL)
Sound Input	1 or 2 Ports (Optional 16 Port)
Sensor Input	1~16 Ports (Optional)
Relay Output	1~4 Ports (Optional)
Composite Output	1 Port (NTSC/PAL, 1 Channel Switching)
Image Format	Software MPEG-4
Recording Mode	Watch, Normal, Motion Detection, Sensor, Scheduled Recording
Remote Control	Full remote control PSTN, ISDN,ADSL, LAN and TCP/IP
Back-up	DAT, CD, DVD
PAN/TILT/ZOOM/FOCUS	RS-232 Interface (Optional RS-422/485 Converter)

2. Products and Components

2-1. ACAP Series Board



120A04



120A08



120A16

2-2. Accessories



8ch Video Pigtail Cable



16ch Video Pigtail Cable



Watchdog Cable

2-3. Optional Accessories



Sensor Port



Sensor & Relay Cable



Audio Cable



RS-485 Board



RS-232C Cable



I/O board (8CH, 16CH)

3. Board Description

3-1. 120A04

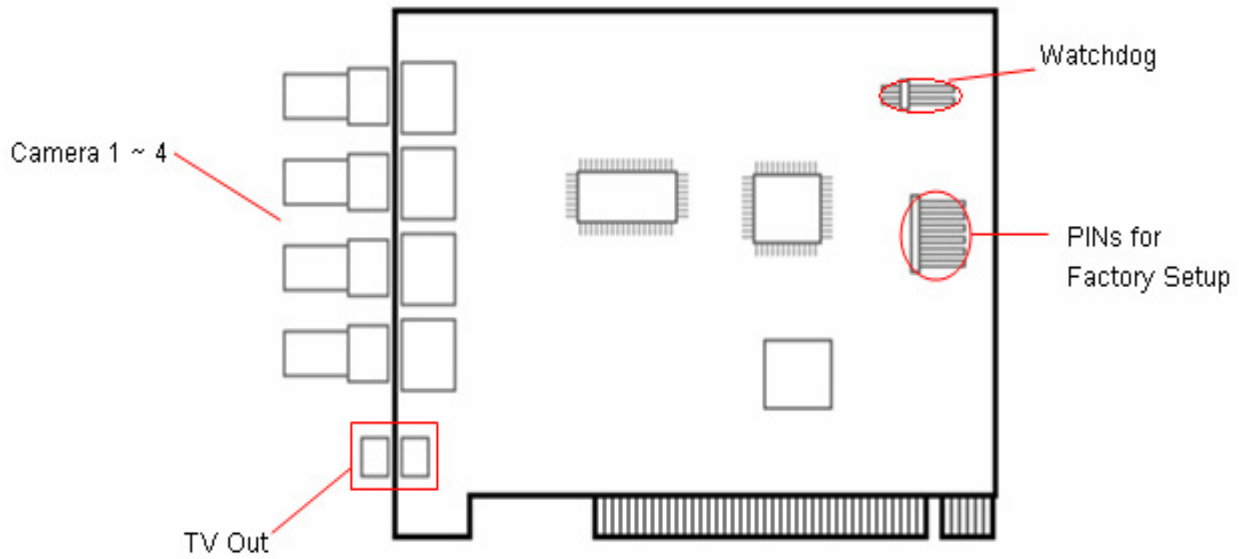

3-2. 120A08

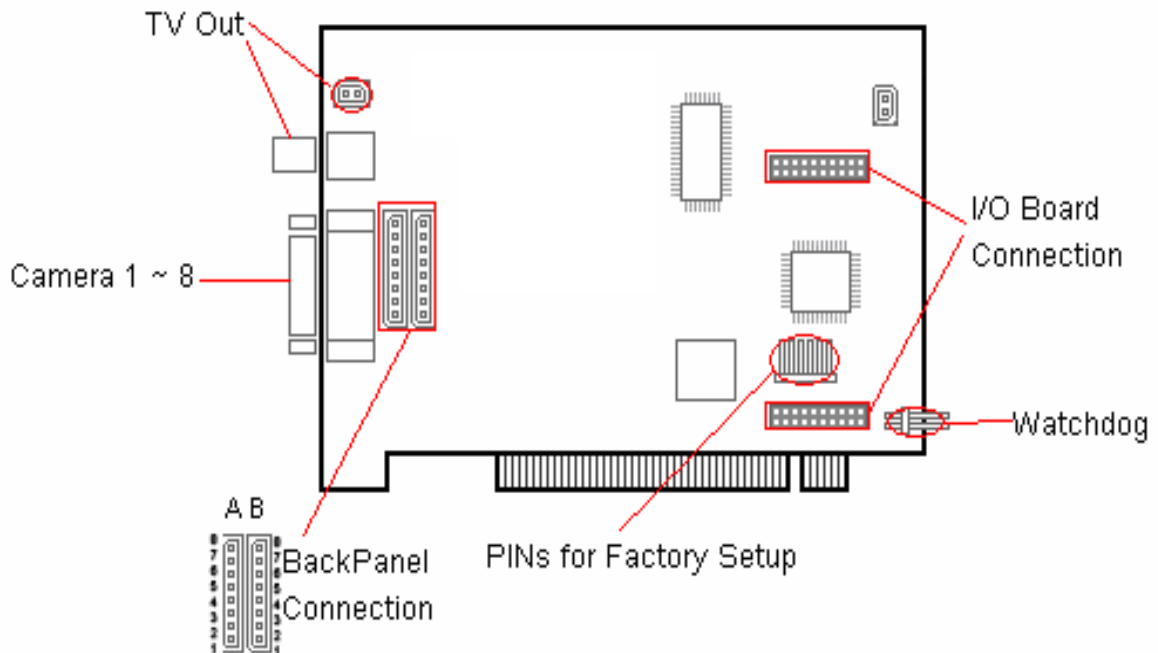

3-3. 120A16

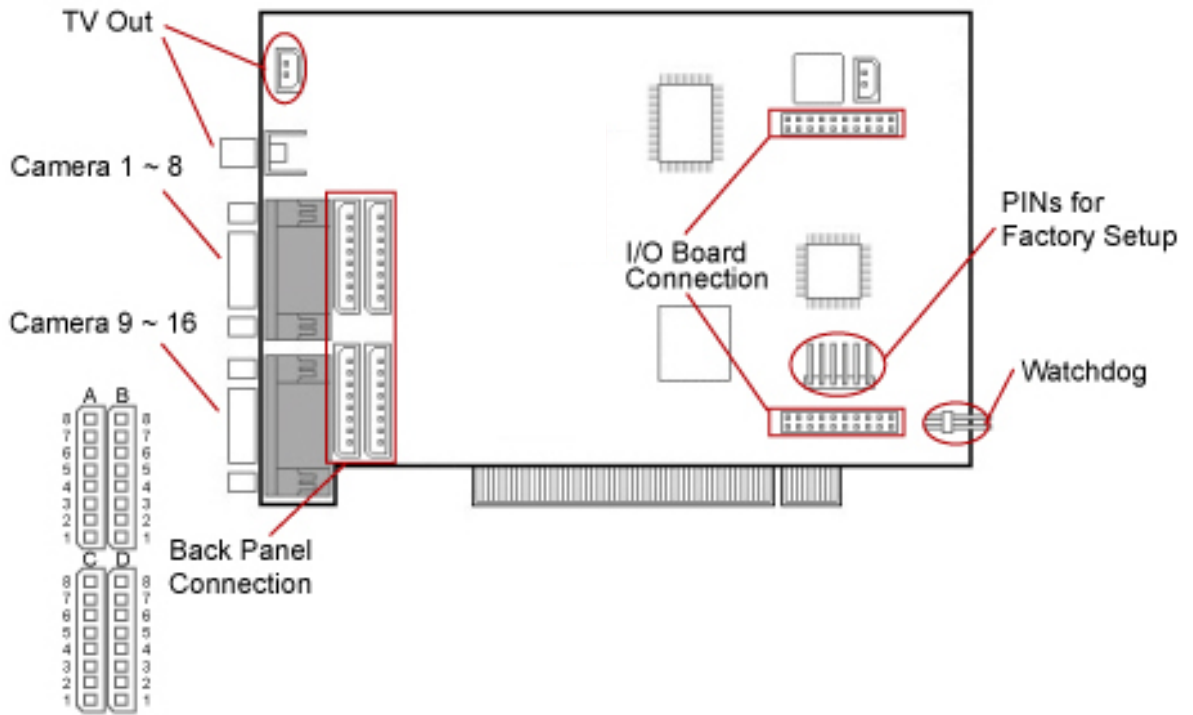

3-4. I/O Board

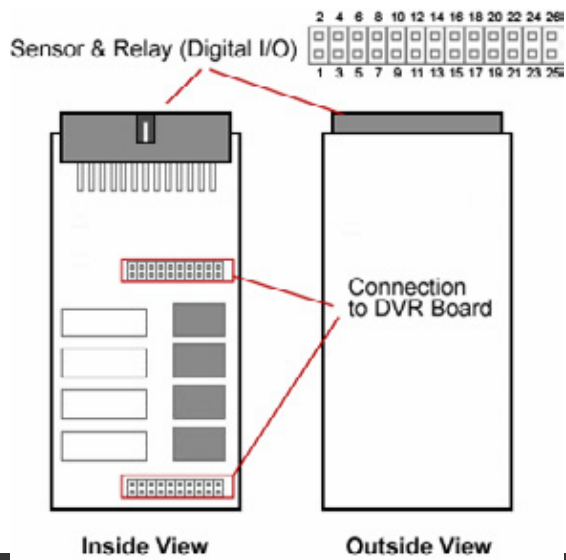

4. Installation

4-1. 120A04

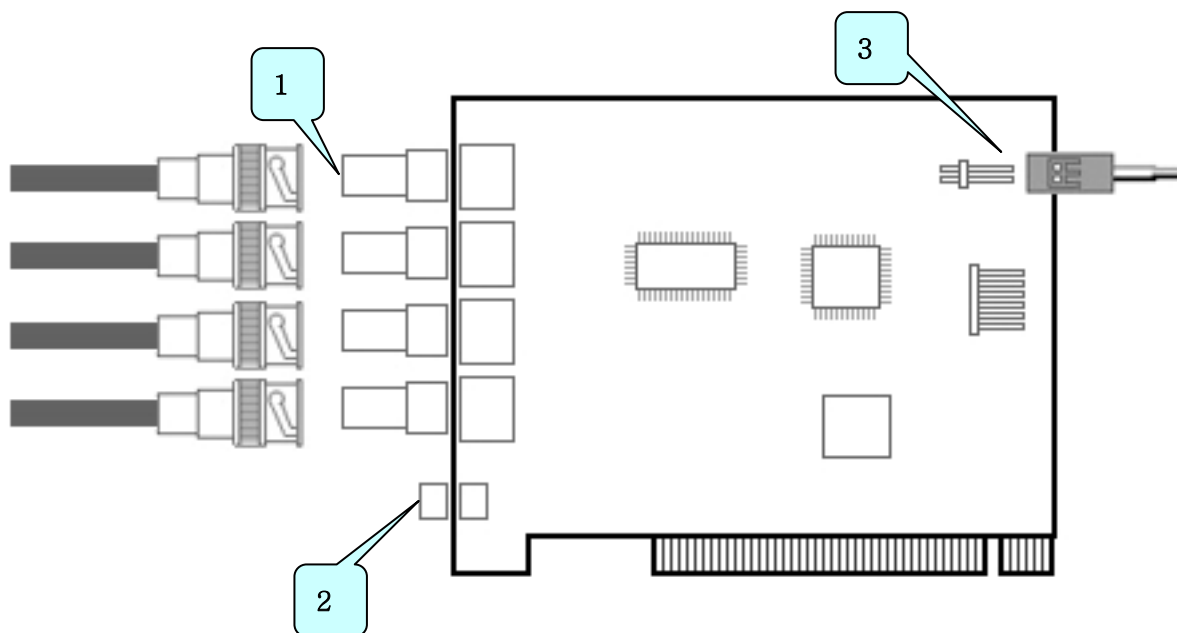

- 1) Connect camera cables to the BNC ports.
- 2) Connect Composite-OUT cable.
- 3) Connect Watchdog cable. Make sure Black cable goes to the bottom as shown below.

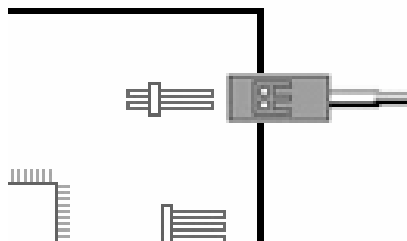

4-2. 120A08

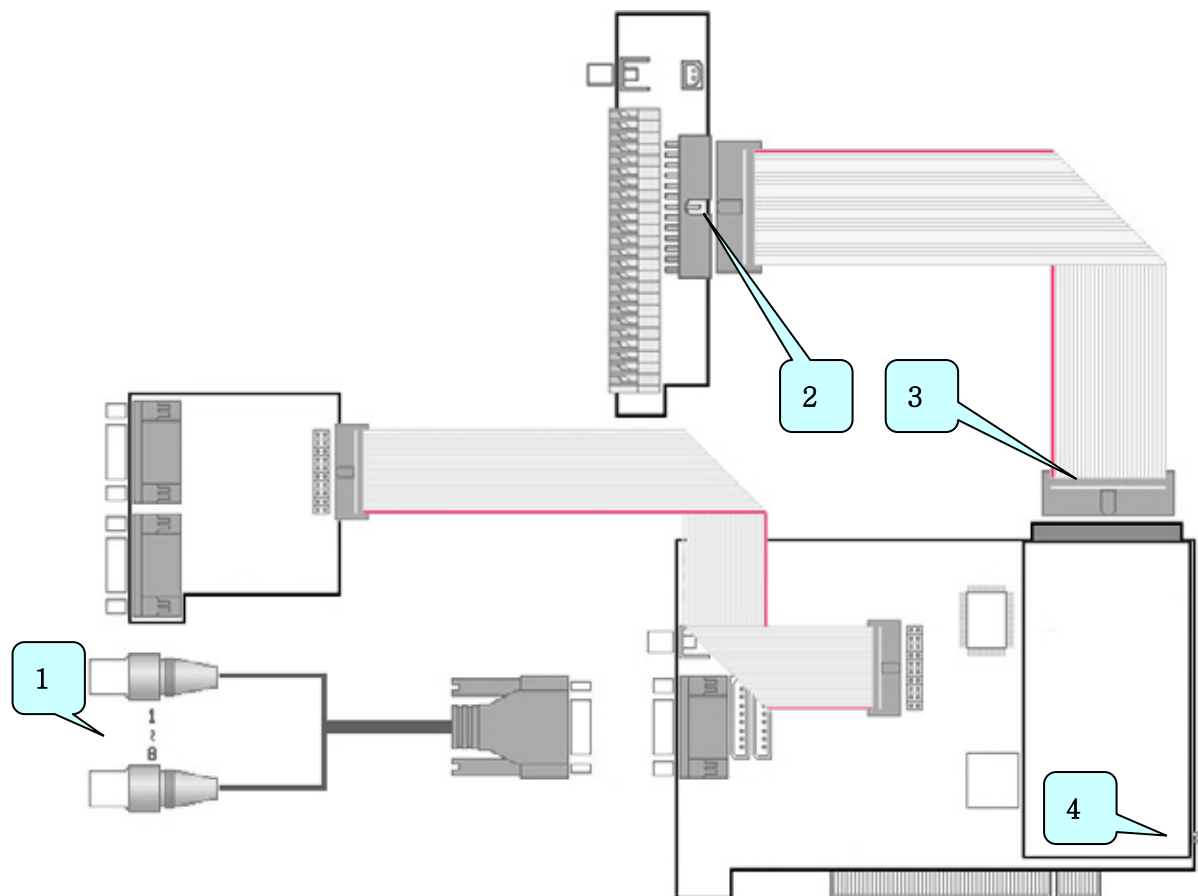

- 1) Connect camera 1~8 to the BNC ports.
- 2) Sensor cable connects to Sensor port.
- 3) The other side of sensor cable connects to IO socket on the DVR board.
- 4) Connect Watchdog cable. Make sure Black cable goes to the bottom as shown below.

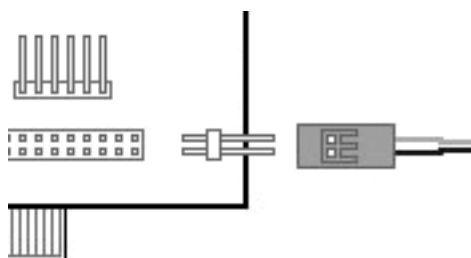

4-3. 120A16

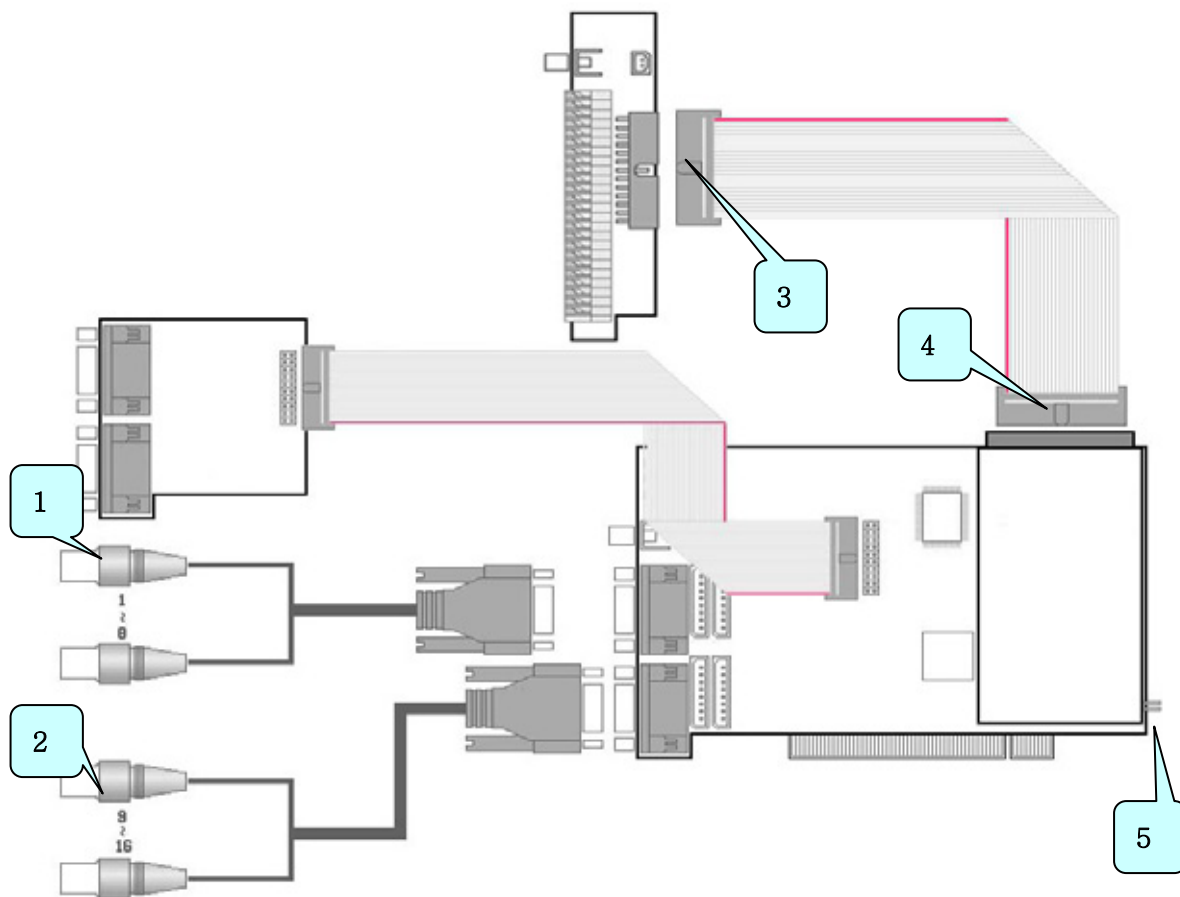

- 1) Connect camera 1~8 to the BNC ports.
- 2) Connect camera 9~16 to the BNC ports.
- 3) Sensor cable connects to Sensor port.
- 4) The other side of sensor cable connects to IO socket on the DVR board.
- 5) Connect Watchdog cable. Make sure Black cable goes to the bottom as shown below.

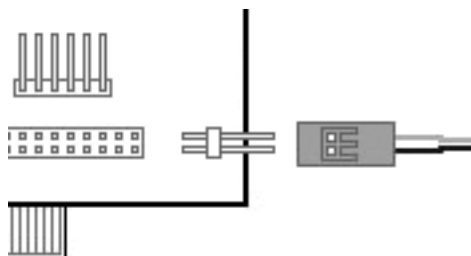

5. Accessories

5-1. Video Pigtail

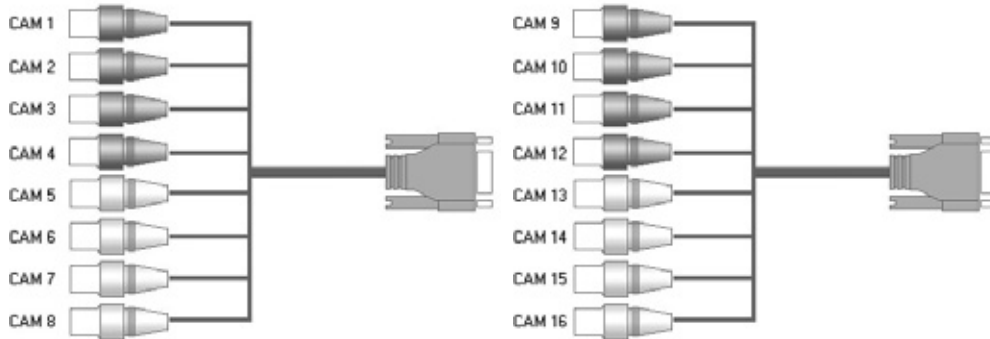

Pigtail cable

- 1 ~ 4, 9 ~ 13 : Black BNC
- 5 ~ 8, 13 ~ 16 : White BNC

5-2. Sensor Board (16 channel)

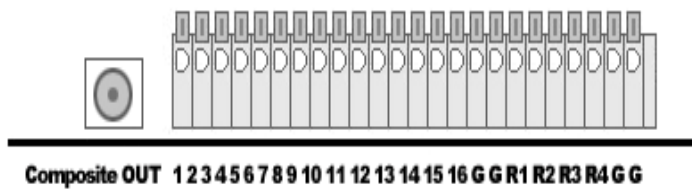

Composite OUT 1 2 3 4 5 6 7 8 9 10 11 12 13 14 15 16 G R1 R2 R3 R4 G G

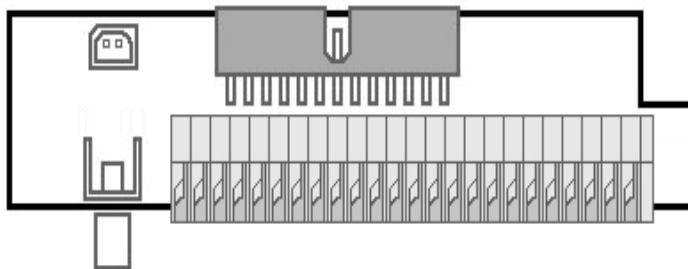

Sensor port pin number

- 1 ~ 16 : Signal input
- G : Ground
- R1, R2, R3, R4 : Relay output

5-3. RS232 to RS422/485 Converter

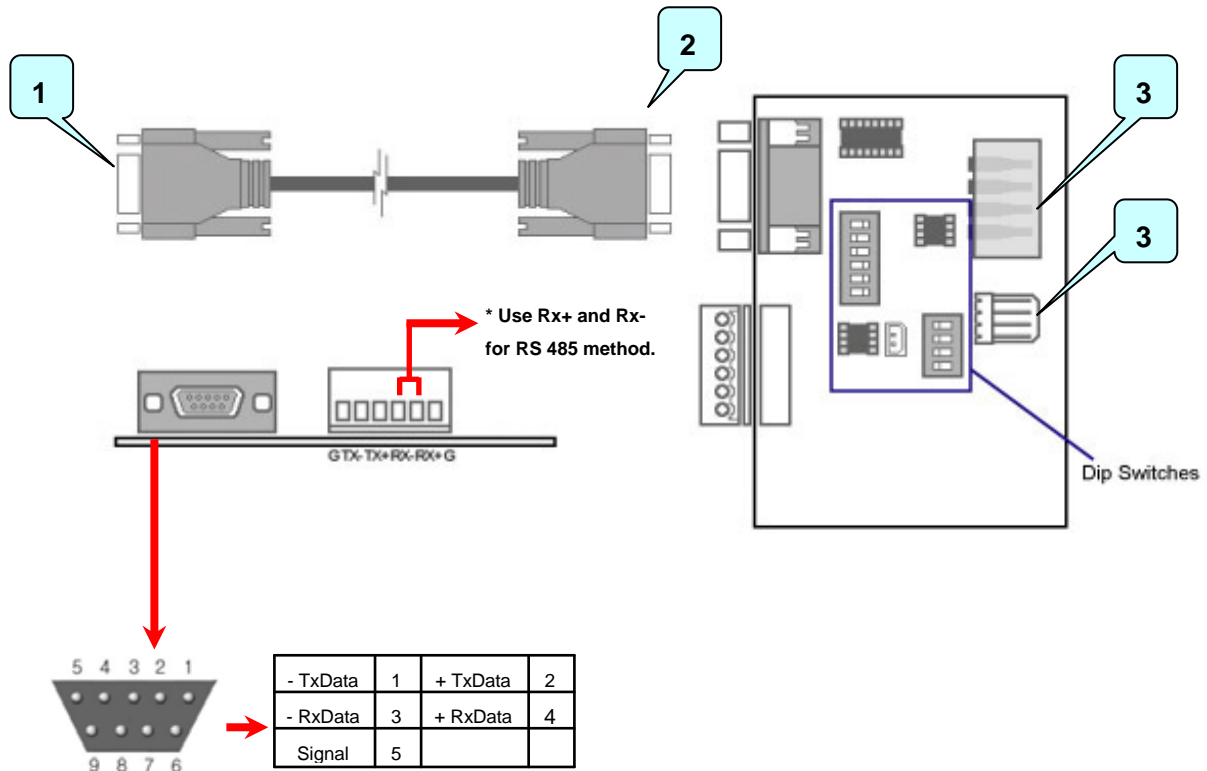

- 1) Connect to system's Com port.
- 2) Connect to PTZ port converter.
- 3) These are power supply sockets. Need to connect only one of them.

Dip Switches

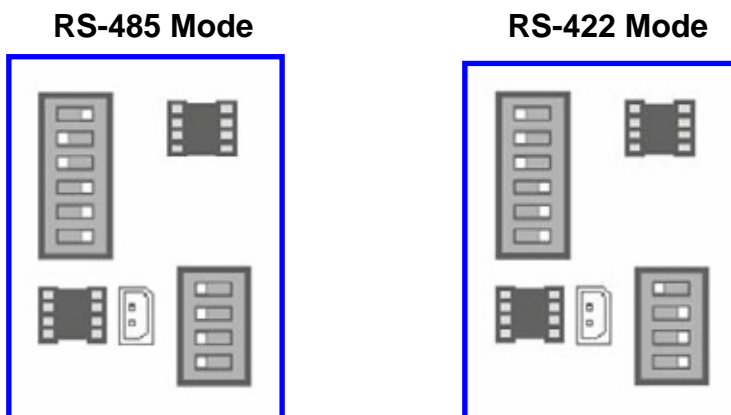

5-4. Sound Recording

After connecting Microphone, ensure that “Line In” and “Microphone In” is not muted in the Windows sound setting. It is required to *have Direct X 8.0 or higher.*

5-4-1. 1 Channel sound

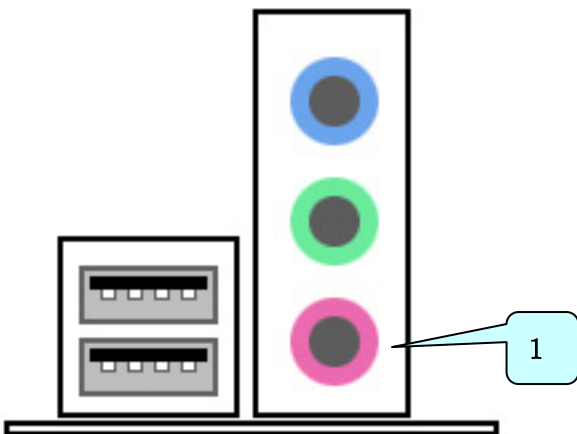

- 1) Connect to “Microphone In” of sound card.

5-4-2. 2 Channel sound

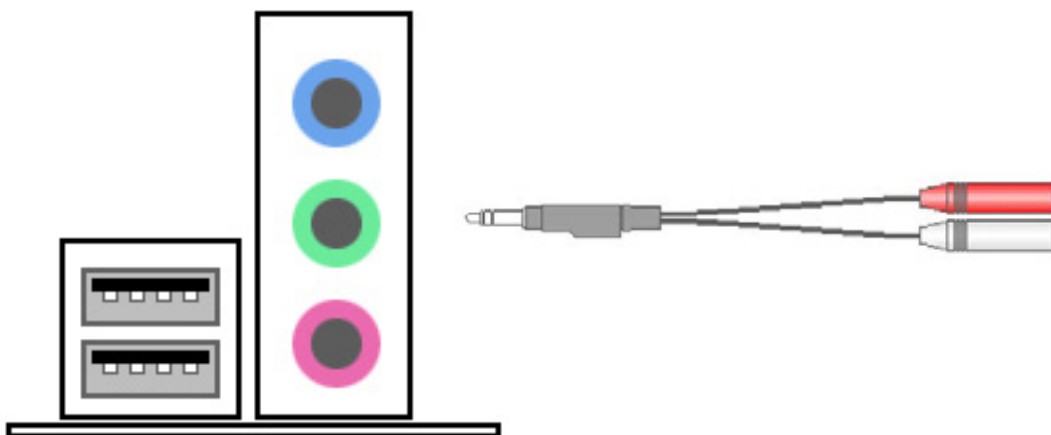

- 1) Connect to “Line In” of sound card with 2 channel audio cable (optional).
- 2) Connect microphones to the audio cable.
 - Must use amplified microphone.

